

Operating & Maintenance Guide





Contents

Welcome To SeceuroGlide	Page 3
Service & Maintenance Record	Page 4
Looking After Your Garage Door	Page 6
Operating Instructions	Page 7
Remotes	Page 8
Setting the Courtesy Light Time	Page 9
Programming Automatic Closing	Page 9
Safety	Page 10
Power Failure	Page 10
– Electrically Operated Products	
– Manually Operated Products	
Trouble Shooting	Page 11
– Electrically Operated Products	
– Manually Operated Products	

To ensure compliance with the Machinery Directive this document must be given to the owner of the door and held for future reference.

Date of installation:	
Installation by:	
Product type:	SeceuroGlide <input type="checkbox"/> SeceuroGlide Excel <input type="checkbox"/> SeceuroGlide Compact <input type="checkbox"/> SeceuroGlide LT <input type="checkbox"/> SeceuroGlide Manual <input type="checkbox"/>
Contact details:	



SeceuroGlide Roller
Anthracite Metallic Finish

Welcome to SeceuroGlide



Thank you for your recent purchase of a SeceuroGlide roller garage door.

Combining great design and exceptional build quality the SeceuroGlide roller garage door you have purchased has been designed and manufactured in the UK and offers attractive, effortless protection for your home.

We understand that the purchasing of your SeceuroGlide roller garage door is a significant investment for you and your property, this has led us to putting together this small guide to allow you to get to know your garage door better.

Your newly-installed product should give you many years of trouble-free service as it is designed to require minimal maintenance and servicing. In order to prolong the life of your door and to reduce the likelihood of problems please adhere to the following instructions. Please note all products should only be operated by trained users.

Wishing you many happy years with your new purchase.

The SeceuroGlide Team

A class of its own

Many features unique to SeceuroGlide

- ✓ Many unique safety, security and design features
- ✓ Enhanced strength, reduced noise and better insulation through curtain, end plate and guide rail engineering
- ✓ A higher level of security by use of extruded aluminium locking attachments which secure the curtain to the barrel
- ✓ Our smart choice SeceuroGlide Connect available exclusively on SeceuroGlide allowing you to operate your door via a smart phone
- ✓ A choice of lighting options both internally and externally
- ✓ Your choice from a wide selection of remote controls

Service and Maintenance Record

We recommend that your SeceuroGlide Roller Garage Door is serviced by an official SeceuroGlide distributor once every 12 months.

Should you require any assistance with your SeceuroGlide Roller Garage Door please only use an official SeceuroGlide distributor and request they fill in the below form with details of any work carried out and replacement parts fitted.

Date:			
Work carried out:			
Work performed by:			
Print:			
Signed:			
Company name:			
Notes:			

Date:			
Work carried out:			
Work performed by:			
Print:			
Signed:			
Company name:			
Notes:			

Date:			
Work carried out:			
Work performed by:			
Print:			
Signed:			
Company name:			
Notes:			

Date:			
Work carried out:			
Work performed by:			
Print:			
Signed:			
Company name:			
Notes:			



SeceuroGlide Roller
White Plain Colour Finish

Looking after Your Garage Door

Tips on maintenance for your new SeceuroGlide Garage Door.

Your garage door is low maintenance:

- ✓ The curtain needs wiping with a damp cloth and a mild detergent to remove any excessive dirt/grime to maintain its appearance and to reduce the risk of the surface being damaged.
- ✓ This must be done more frequently in a salt air environment.
- ✓ Marks on the paint finish can be cleaned with many types of car polish.
- ✓ Chips in the paint work should be touched up to prevent corrosion of the metal.
- ✓ The power to the garage door should be isolated before washing or repairing the paintwork.
- ✓ The motor and curtain have been designed to be lubrication free so you must not oil or grease the guide rails.
- ✓ Make sure no foreign items get collected in the guides i.e: stones, sticks, paper etc.

Additional information

for electrically operated products

Your door should run smoothly and easily as the motor is not designed to over-come problems of a badly running or damaged door. If necessary contact your approved installer for repair.

The motor should be stopping on the limits and not over-running (indicated by buzzing) when the door hits the floor or the open stops.

N.B. Always isolate the power before attempting to make any adjustments or repairs. Untrained operators are advised to contact an approved installer.

Operating Instructions

Electrically Operated Products

Whenever possible the garage door should be operated when it is in view, making sure it is not obstructed. Ensure when the curtain is running, that you and any other person stands clear of the curtain and keeps hands etc. away from the moving parts.

Control Unit

Please note the front of the control unit should only be removed by a trained engineer. Your garage door can be activated by pressing and releasing the buttons on the front of the control unit, the button on your remote handset, or a separate wall switch that you may have installed.



SeceuroSense
Control unit

Hand Transmitters

The transmitters are fitted with two, three or four buttons (see diagram) and when any button is pressed the LED illuminates.

The buttons on remotes can be programmed to suit your requirements. The default setting is one button operation that allows you to lift, stop and close the door.

PLEASE NOTE

When opening or closing the garage door you must monitor the product until it has completed its operation. If the product is fitted with a safety device this could be activated during its operation which would cause the door to stop and reopen a short distance leaving the door partly open.

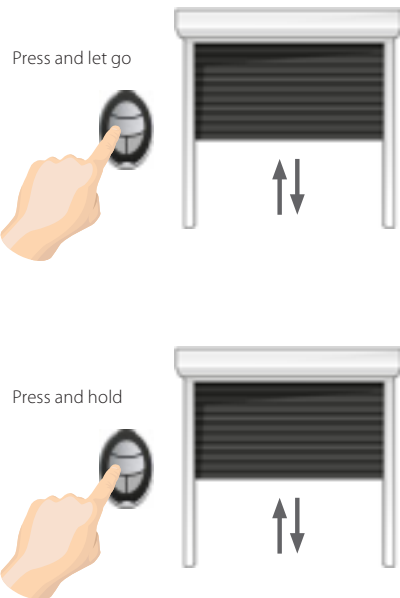

Setting the Courtesy Light Time

(From 1 minute to 12 hours)

This procedure means the courtesy light will remain on after operating the door for a designated period of time.

1. Turn the power off for a minimum of 5 seconds.
2. Turn the power on and start the procedure within 30 seconds of the power being switched on.
3. Press and hold button P3 on the back of the remote for 5 seconds, a beep will sound.

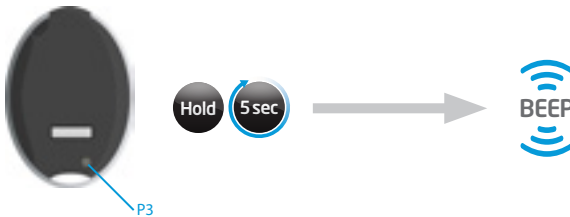

4. Press button P3 5 times and wait for 5 seconds until 3 beeps sound.

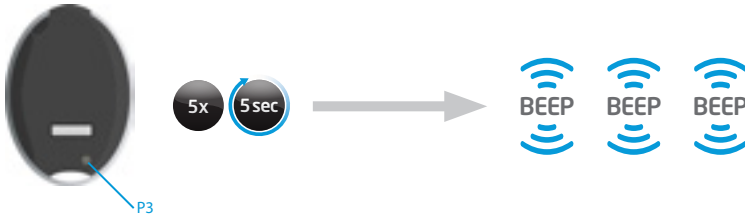

5. Press button P3 you will hear one beep that signifies timing of the courtesy light. (EG: If you would like the light to remain on for 30 seconds, time 30 seconds from the beep.) The light can be programmed from 1 minute to 12 hours.
6. When the desired time has elapsed press again button P3 on the remote to exit programming and set the courtesy light.

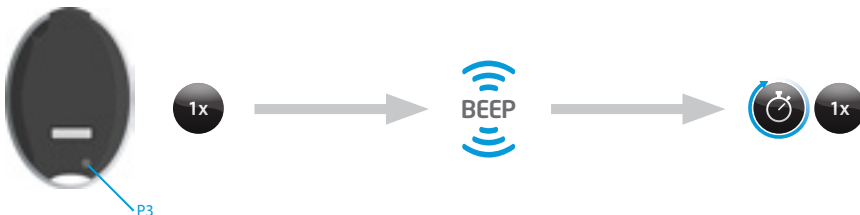

Activating Holiday Mode

This allows the user to disable the buttons on the front of the receiver.

To Lock

1. Press and hold the "stop" button on the front of the receiver for 5 seconds (beep). The LED  will flash slowly to indicate that the unit is in holiday mode*

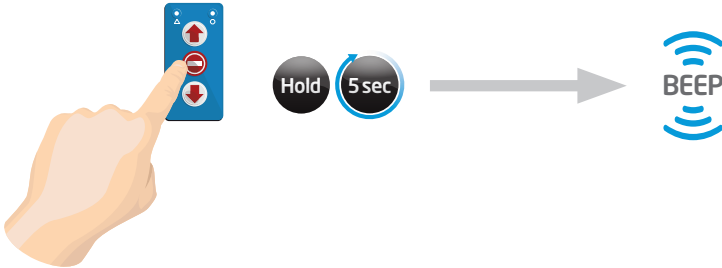

To Unlock

1. Press and hold the "stop" button on the front of the receiver for 5 seconds (beep)

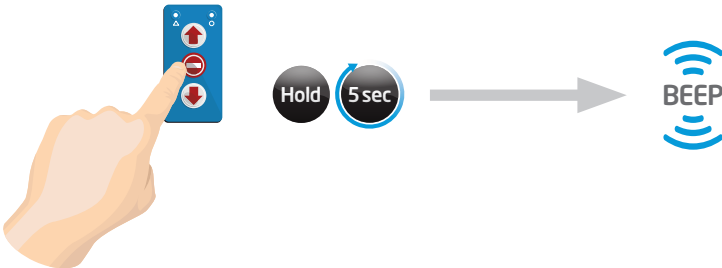

2. Now press the button on your remote control (beep)
The door is now out of holiday mode*

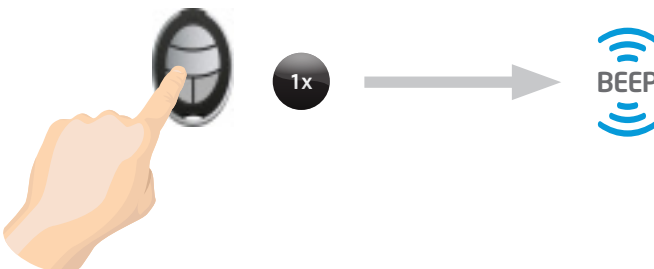

*Only applicable on products ordered from the 1st of June 2013

Remotes

Your SeceuroGlide roller garage door will be supplied with two remote controls from the selection below. Whilst the default setting is to use one button to operate the door please speak to your approved installer if you would like a two button operation.



Adding Remotes



STEP 1

Press the back of the programmed remote "P3" with a paperclip once then release. (Long Beep)



STEP 2

Press the function button on the front of the remote for the function you would like to copy. (Long Beep)

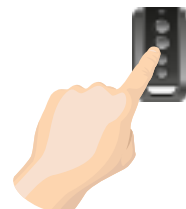

STEP 3

Press the button on the new and unused remote you would like to copy the function to. (Short Beeps)

Safety

Safety Edge

The Safety Edge is fitted to the bottom of the door and is activated when the door starts to close. If it comes into contact with an object while the door is closing, it transmits a signal to the wall mounted control unit, the door will then stop and reopen a short distance.

The safety edge also works as a weather seal, designed to be pressed against the ground.

Safety Devices

The standard remote control receiver unit is supplied with an optical safety edge as standard.



Power Failure

Electrically Operated Products

If your roller garage door is not working correctly please contact your installer for assistance. **N.B:** Always isolate the power before attempting to make an adjustment or repair. Untrained operators are advised to contact an approved installer.

Power Failure

In the event of disruption to the power supply, or the motor temporarily over heating (the motor is protected by a thermal cut out), the door can be operated manually. Isolate power supply before using the manual override.

To operate: Hold crank handle in line with eye and rotate handle until the door reaches the open/closed position.

DO NOT OVERWIND

When the main power is reinstalled, ensure that the power isolator is switched back on. If applicable secure the handle back onto the wall. Remember to keep the crank handle in a convenient place.

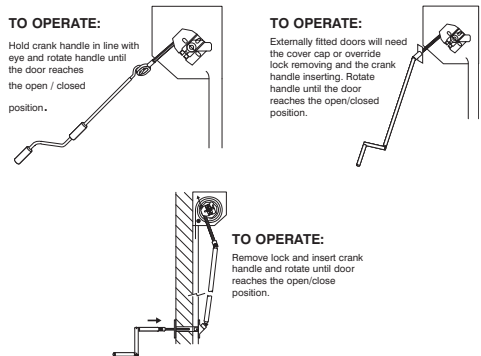

Manually Operated Products

Make sure there are no obstructions. Ensure when the curtain is running, that any other person stands clear of the curtain and keeps hands etc. away from moving parts. You will have a lock in the locking slat.

Opening the garage door

Press slightly down on the handle when the garage door is in the closed position; disengage the locking mechanism(s). Ensure the key is removed before opening the garage door. Push the garage door curtain upwards to open. Do not let go of the garage door until it has reached its open position.

Closing the garage door

Pull the garage door down using the handle provided. When the door reaches the close position press down on the handle to engage the locking mechanism.

Trouble Shooting

Electrically Operated Products

Fault	Possible Cause	Solution
Transmitter not working	Batteries flat	Change batteries.*
Door closes but immediately re-opens	Safety edge activated	Sweep the floor to ensure it is clear of obstructions and check the integrity of the safety edge.
Door only come down partially before re-opening slightly	Safety edge fault	Check batteries in bottom slat transmitter.**
Door will open but only close in dead man mode***	Batteries flat	Change batteries in bottom slat transmitter.**
5 rapid beeps	Batteries Low in bottom slat transmitter	Check Batteries in bottom slat transmitter.** N.B: the receiver will still give a series of rapid beeps for approx. 1 minute after replacing the batteries.

Manually Operated Products

Fault	Possible Cause	Solution
Lock will not engage	The lock is not correctly aligned with the lock hole.	Apply more pressure to the bottom of the curtain until the lock engages or move the curtain around slightly until it is in the correct position for the lock(s) to engage.

* Transmitter batteries are CR2032 2v batteries

** Bottom slat transmitter batteries are AA size 3.6 lithium batteries

*** If the door fails to close when a button is pressed you can close the door in dead man mode by keeping your finger on the button until the door fully closes. There will be a delay before the door starts to operate. When in this mode if you release your finger from the button the door will stop